

High-Pressure Pumps in Ring-Section Design



Automation products available:

- PumpExpert
- Hyamaster
- hyatronic

Applications

- General water supply
- Pressure boosting
- Municipal water supply
- Drinking water supply
- Irrigation
- Heating
- Boiler feed water
- Warm water
- Hot water
- Circulation
- Condensate
- Distillate
- Industry
- Filter systems
- Solvents
- Fire-fighting systems
- Washing systems
- Reverse osmosis
- Lubricants
- Fuels
- Process
- Power plants

Operating data

Pump sizes	DN 32 up to 150
Capacities	Q up to 850 m ³ /h, 236 l/s
Heads	H up to 630 m
Operating temperature	t -10 °C up to +200 °C
Operating pressures	p ₂ 25 up to 63 bar ¹⁾
Standard flanges	DIN
Suction nozzle	PN 16 (JL1040) and PN 25 (GP240GH+N, 1.4408)
Discharge nozzle	PN 40 (JL1040) and PN 63 (GP240GH+N, 1.4408)
Standard flanges	ASME
Suction nozzle	Class 125 (JL1040) and Class 300 (GP240GH+N, 1.4408)
Discharge nozzle	Class 250 (JL1040) and Class 600 (GP240GH+N, 1.4408)

1) The total of inlet pressure and head at zero flow must not exceed the specified value

Design

Horizontal or vertical multistage centrifugal pump in ring section design, as long-coupled (baseplate mounted) or close-coupled unit.

Axial or radial suction nozzle. Radial suction and discharge nozzle can be turned in multiples of 90°.

Flanges to EN, DIN and ANSI (bolt holes, flange face)

Closed radial impellers, from pump size 50 upwards first stage with suction impeller to improve the NPSH value.

Bearings/Lubrication

Drive side: rolling element bearings

Suction side: plain or rolling element bearings, depending on installation type

Lubrication: Rolling element bearings grease lubricated, oil lubrication possible
Plain bearings are product lubricated.

Shaft seal

Standardized mechanical seal, uncooled or cooled, single-acting or double-acting.
Cartridge seals possible.

Uncooled gland packing with or without barrier liquid.

Designation

	Multitec	A	32 / 8E - 2.1	12 . 65 (SP)
Pump series	_____			
Installation type	_____			
DN discharge nozzle	_____			
Number of stages/Impeller combination	_____			
Hydraulics	_____			
Material variant	_____			
Shaft seal code	_____			
Code for special variants (optional)	_____			

Materials

Cast iron JL1040,

Hydraulic elements: bronze CC480K-GS (water works variant), cast steel GP240GH+N, alloyed cast steel 1.4408

Drive

Electric motor 50 and 60 Hz;

Diesel engine or turbine up to n_{max}. 4000 1/min possible

Certification

Certification of quality management ISO 9001

Selection charts

n = 2900 1/min (1.4408)

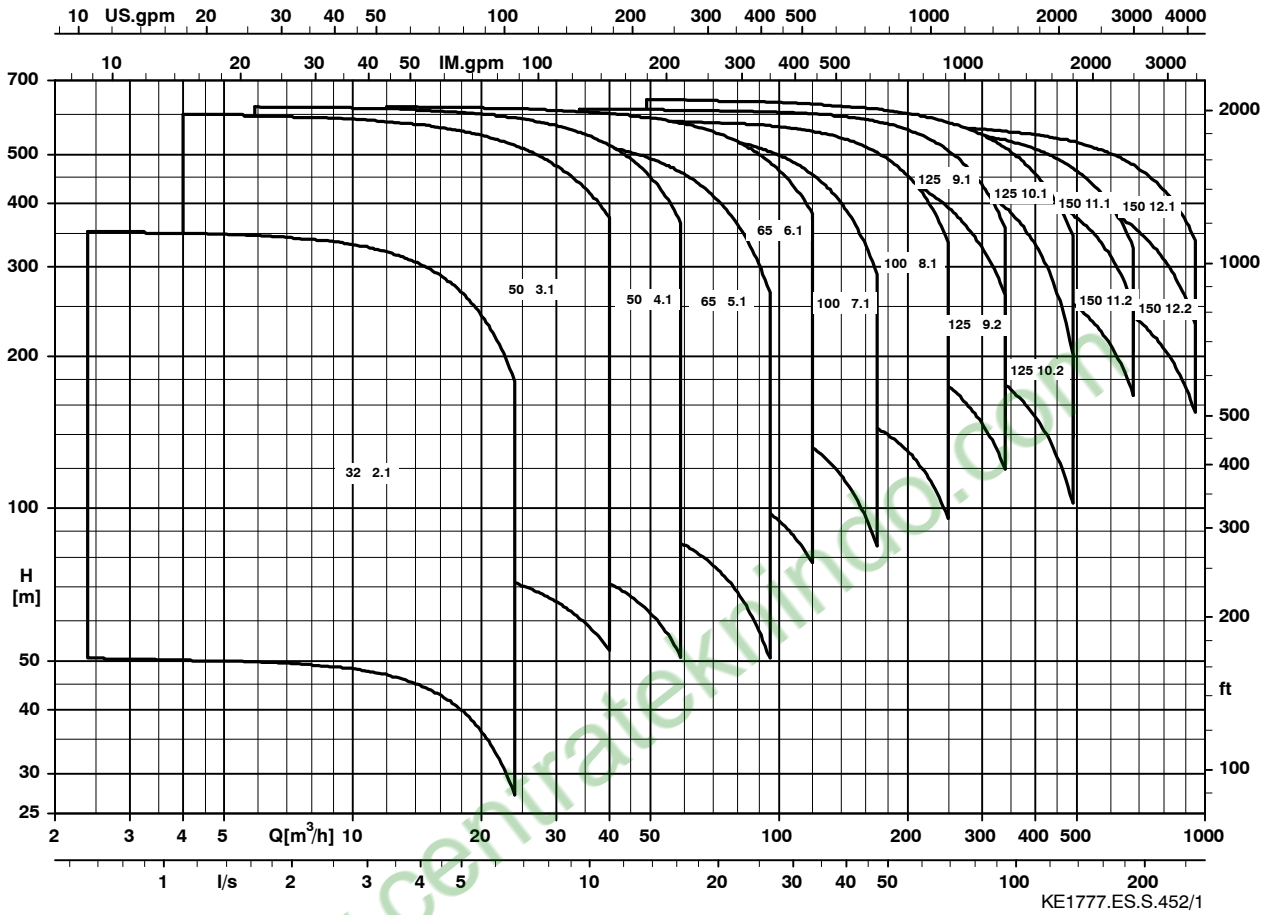

n = 3500 1/min (1.4408)

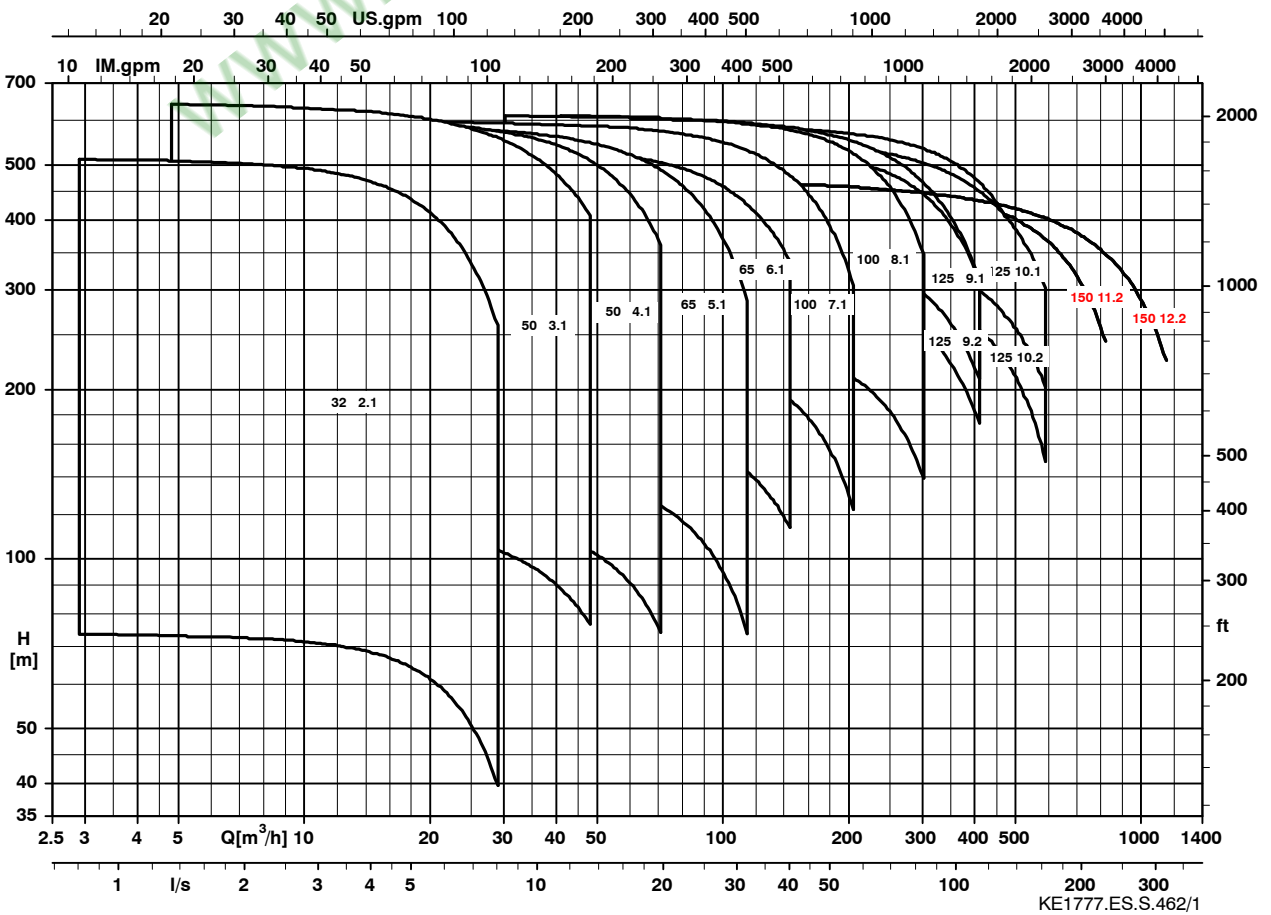

Selection of material/shaft seal depending on the pumped liquid

Pumped liquid	Material			Shaft seal			Notes
	p ₂ max in bar	≤ 140 °C	≤ 200 °C	≤ 100 °C	≤ 140 °C	≤ 200 °C	
Sewage, raw water ¹⁾ slightly contaminated water	40 63	10 20		63, 65			Non-aggressive pumped liquid, no abrasive components
Drinking water ¹⁾	40 63	11,12 25,26		65,61 ⁵⁾ ,67			Water works variant
Fire-fighting water ¹⁾	40	11,12		65,61 ⁵⁾ ,62			
Cooling water	40 63	10 20		65,61 ⁵⁾ ,62			Non-aggressive pumped liquid, no abrasive components
Boiler feed water ²⁾ Operating mode AF, pH > 9 (objective ≥ 9.3) at 25 °C	40 63	10 20	20 20	65,61 ⁵⁾ ,62	66, 62	64	O ₂ content ≤ 0.02 mg/kg
Boiler feed water ²⁾ Operating mode AFT, pH > 9 (objective ≥ 9.3) at 25 °C	40 63	22 22	22 22	65,61 ⁵⁾ ,62	62	64	
Boiler feed water ²⁾ Operating mode AFT, pH > 9 (objective ≥ 9.3) at 25 °C	40 63	10 20	20 20	65,61 ⁵⁾ ,62	66, 62	64	O ₂ content ≤ 0.02 mg/kg
Boiler feed water ²⁾ Operating mode NF, pH ≥ 6.5 at 25 °C	40 63	30 30	30 30	61 ⁵⁾ ,62	62	64	O ₂ content ≥ 0.05 mg/kg
Boiler feed water ²⁾ Operating mode KF, pH ≥ 8 - 8.5 at 25 °C	40 63	22 22	22 22	65,61 ⁵⁾ ,62	66, 62	64	O ₂ content 0.15 up to 0.3 mg/kg
Condensate ²⁾ Operating mode AF, pH > 9 (objective ≥ 9.3) at 25 °C	40 63	10 20	20 20	61 ⁵⁾ ,62	62	64	O ₂ content ≤ 0.02 mg/kg temperature ≤ 190 °C ⁴⁾
Condensate ²⁾ Operating mode NF, pH ≥ 6.5 at 25 °C	40 63	30 30	30 30	61 ⁵⁾ ,62	62	64	
Condensate ²⁾ Operating mode KF, pH ≥ 8 at 25 °C	40 63	22 22		65,61 ⁵⁾ ,62	66, 62	64	O ₂ content ≥ 0.15 mg/kg temperature ≤ 110 °C ⁴⁾
Raw water for reverse osmosis plants	40 63	30 30	30 30	61 ⁵⁾ ,62	62	64	For higher chloride content (sea water) contact KSB In case of prolonged shutdown, drain and flush the pump
Oil-water mixture, oil emulsion	40 63	10 20		65, 63			
Glycol-water mixtures	40 63	10 20		65,61 ⁵⁾ ,62	66, 62		
Degreasing baths, washing solution for metal cleansing, alkaline cleaning agents	40 63	10 20		65,63			³⁾ e.g. P ₃ -lye for acid baths please contact KSB
Chp rmovalimulsion for aluminium machining	40 63	10 20		68			

1) General assessment criteria when a water analysis is available: pH value ≥ 6.5; chloride content (Cl⁻) ≤ 150 mg/kg, chlorine (Cl₂) ≤ 0.6 mg/kg. For bronze components, the following additional limits apply: ammonia (NH₃) ≤ 5 mg/kg, free of hydrogen sulphide (H₂S); the limitation of the Cl⁻ content does not have to be applied in this case. If these limits are not complied with, please contact KSB.

2) The values must be assured upstream of the pump inlet under all operating conditions. Water treatment shall comply with the VdTUV regulations for feed and boiler water grades for steam plants up to 64 bar. Air ingress into the system must be avoided by all means. We therefore recommend to use a mechanical seal as a shaft seal. Notes for the suction pipe layout: Max. flow velocity approx. 1.5 m/s, low pressure loss arrangement (few pipe fittings/valves, low drag valves, e.g. gate valves instead of globe valves, pipe arrangement short and vertical, horizontal sections should be located at the deepest position). Using impellers made of G-CuSn10 is only possible when no additives containing ammonia (e.g. Hydrazin) are used for water treatment.

3) max. 80 °C; pH value > 9.5

4) Values drawn from experience

5) See application limits on page 6

AF = Water is fully demineralised, pH value set to > 9 (e.g. using ammonia).

AFT = Water is partly demineralised, pH value set to ≥ 9, mainly with solid alkalisating agents, possibly additional dosing of ammonia.

NF = Water is fully demineralised, pH value ≥ 7-8, O₂ content increased to ≤ 0.05-0.25 mg/kg by adding oxygen or hydrogen peroxide.

KF = Water is fully demineralised, alkalisated to pH values from 8 to 9, O₂ content increased to ≤ 0.03-0.15 mg/kg by adding oxygen or hydrogen peroxide.

Operating ranges depending on installation type

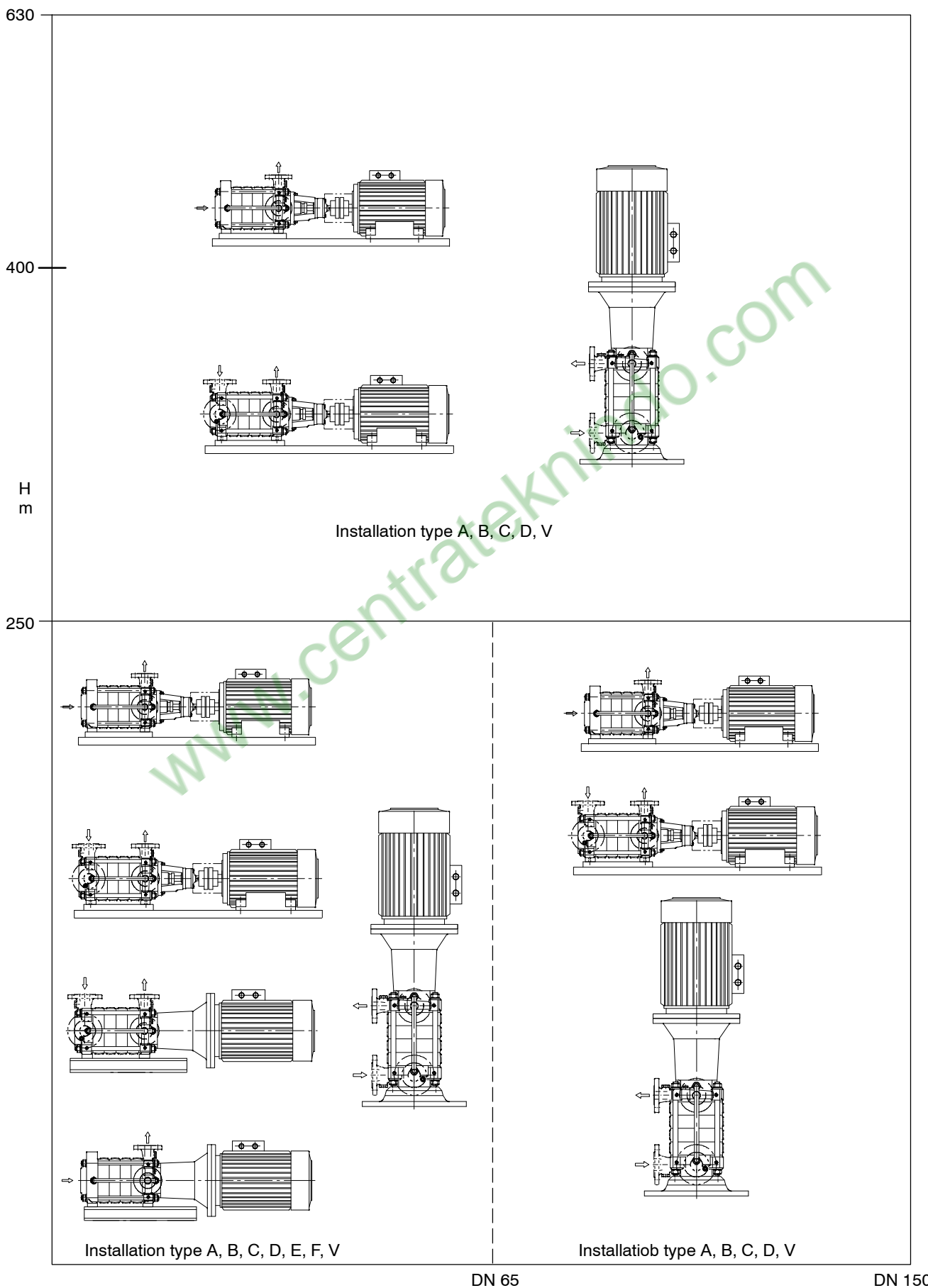

Heads given for n=2900 1/min and n=3500 1/min

Technical Description

Installation type	Technical description			
Installation type A ⁴⁾ 	Horizontal design, baseplate mounted, rolling element bearings on drive side, plain bearings on suction side, one shaft seal only, axial suction nozzle (block flange up to pump size 50), drive on discharge side For the entire Q/H range	Drive	Electric motor, Diesel engine, turbine	
		Axial thrust balance	By balance drum ¹⁾	
Installation type B ⁴⁾ 	Same as installation type A, but with radial suction nozzle	$Q_{max}^{2)}$	840 m ³ /h	
		H_{max}	630 m	
Installation type C ⁴⁾ 	Horizontal design, baseplate mounted, rolling element bearings on drive and suction side, shaft seals at both ends, drive on discharge side For the entire Q/H range	Drive	Electric motor, Diesel engine, turbine	
		Axial thrust balance	By balance drum ¹⁾	
Installation type D ⁵⁾ 	Same as installation type C, but drive on suction side	$Q_{max}^{2)}$	840 m ³ /h	
		H_{max}	630 m	
Installation type E ⁴⁾ 	Horizontal close coupled pump, common bearing for pump and motor, rigid coupling, radial suction nozzle up to DN 65	Drive	E, F Standardized motor	
		Axial thrust balance	By balance drum	
Installation type F ⁴⁾ 	Same as installation type E, Ex, but with axial suction nozzle up to DN 65	$Q_{max}^{2)}$	100 m ³ /h	
		H_{max}	250 m	
Installation type V ⁴⁾ 	Vertical close coupled pump Q/H range ²⁾ : 2-pole: up to $Q_{Opt}=120$ m ³ /h, 630 m up to $Q_{Opt}=240$ m ³ /h, 400 m 4-pole: up to $Q_{Opt}=340$ m ³ /h, 250 m	Drive	Standardized motor - fixed bearing, drive-end	
		Fixed bearing in lantern	DN 32 DN 50 DN 65	Standardized motor ³⁾ DN 100 DN 125 DN 150
			Held by motor bearing	By balance drum
		Axial thrust balance	by balance drum	
		$Q_{max}^{2) 3)}$	100 m ³ /h	300 m ³ /h
		$H_{max}^{3)}$	630 m	400 m
		$p_{2 max}^{3)}$	63 bar	
		t_{max}	-10 up to +140 °C	
		Shaft seal	Uncooled packing; uncooled mechanical seal single-acting	
		Material	Grey cast iron JL1040, bronze CC480K-GS, cast steel 1.0619+N, 1.4408	

1) For small number of stages without balance drum: axial thrust fully held by the axial bearings
 2) N.B.: The values given for Q apply to 50 Hz; for 60 Hz values please refer to the specific performance curves.

3) Other operating data on request
 4) Clockwise drive rotation when viewed from the motor end
 5) Anti-clockwise drive rotation when viewed from the motor end
 6) On Multitec 32 - 50 - 65 the motor bearings on the coupling side are fixed bearings

Pressure and temperature limits

Material JL1040 (GJL-250)

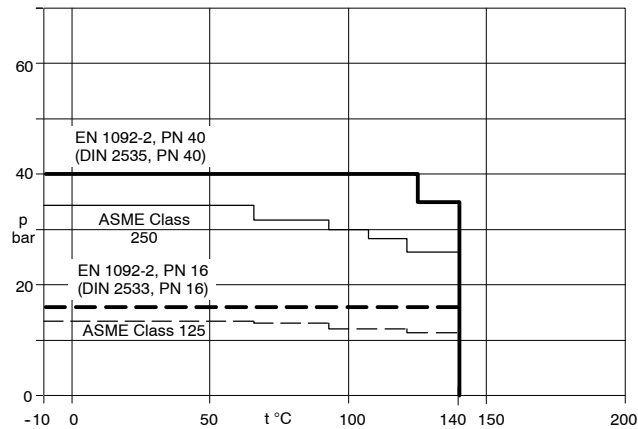

Material 1.4408

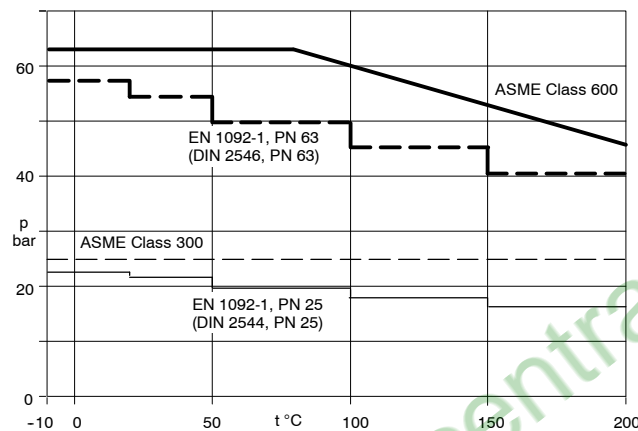

Material GP240GH+N (1.0619+N)

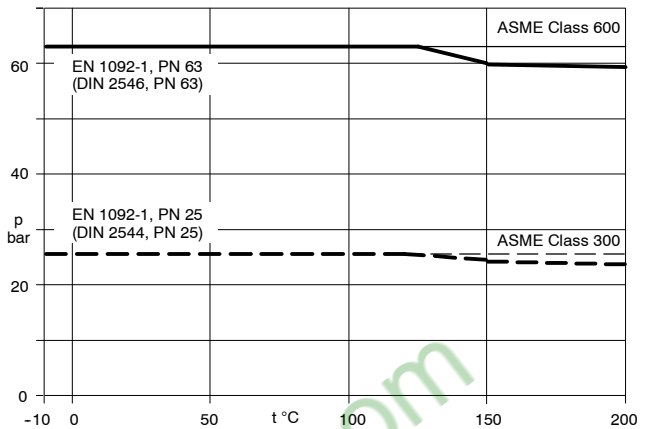

Shaft seal code ²⁾

Mechanical seal			
	Uncooled mechanical seal		Cooled mechanical seal
Temp. limits	up to 100 °C	up to 140 °C	up to 200 °C ³⁾
Non-balanced bellows-type seal RMG 13 (U ₃ BEGG)	61 ^{1) 4)} pump sizes 32 and 50 only	-	-
Balanced seal H12N (AQ ₁ EGG)	62 ⁴⁾	62 ⁴⁾	-
Balanced seal Solids-laden media H17GN (Q ₁₂ Q ₁ VGG) ⁶⁾	63 ⁵⁾	-	-
Balanced seal H75N (AQ ₁ EGG)	-	-	64 ⁴⁾
Balanced seal H17GN (Q ₁₂ BEGG)	67 ⁴⁾⁶⁾	-	-
Non-balanced bellows-type seal MG13 (U3U3VGG)	68 ⁵⁾⁷⁾ pump sizes 32 to 65 only	-	-
Balanced seal HRN (AQ1EMG)	69 ⁴⁾⁸⁾	69 ⁴⁾⁸⁾	-
Gland packing			
	P _{max}	up to 100 °C (GRAFIT / PTFE)	up to 140 °C (GRAFIT / PTFE)
without balance drum	25 bar	65 ⁵⁾	66 ⁴⁾
with balance drum	63 bar		
Design	N/b		N/c
Plant conditions	with suction head operation P _{S abs.} ≥ 1 bar		P _{S abs.} < 1 bar (vacuum vessel) with clean external sealing liquid barrier pressure > pressure to be sealed
Technical features	without lantern ring		1 lantern ring on suction side 1 lantern ring on discharge side 2 tapped holes for auxiliary pipework

1) p_{max} without balance drum = 18 bar; p_{max} with balance drum = 63 bar

2) Other seal variants on request

3) Air-cooled up to DN 100 (installation types A, B, C and D, electric motor IP 55, 2-pole, only); otherwise water-cooled.

4) static seals in EPDM

5) static seals in FPM

6) H7N for pump size 150

7) MG1S4 for pump size 65

8) For suction lift operation

Materials table

Part no.	Description	Material code				
		10 ³⁾	11 ³⁾	12 ³⁾	13 ³⁾	20
106	Suction casing	JL1040	JL1040	JL1040	JL1040	GP240GH+N
107	Discharge casing	JL1040	JL1040	JL1040	JL1040	GP240GH+N
108	Stage casing	JL1040	JL1040	S355J2G3 ¹⁾ / JL1040 ²⁾	JL1040	S355J2G3 ¹⁾ / GP240GH+N ²⁾
171	Diffuser	JL1040 ²⁾⁶⁾	JL1040 ²⁾⁶⁾	CC480K-GS	JL1040 ²⁾⁶⁾	JL1040
210	Shaft	C45+N ⁴⁾	C45+N ⁴⁾	C45+N ⁴⁾	C45+N ⁴⁾	C45+N ⁴⁾
230	Impeller	JL1040	CC480K-GS	CC480K-GS	JL1040	JL1040
231	Suction impeller	JL1040	CC480K-GS	CC480K-GS	1.4408	JL1040
350	Bearing housing	JL1040	JL1040	JL1040	JL1040	JL1040
381/529	Plain bearing assy.	SiC/SiC	SiC/SiC	SiC/SiC	SiC/SiC	SiC/SiC
441	Stuffing box housing	JL1040	JL1040	JL1040	JL1040	GP240GH+N
502 ⁷⁾	Casing wear ring	JL1040 ²⁾	1.4138 ²⁾	1.4138 ²⁾	JL1040 ²⁾	JL1040
523	Shaft sleeve	1.4057+QT800	1.4057+QT800	1.4057+QT800	1.4057+QT800	1.4057+QT800
524	Shaft protecting sleeve	1.4122	1.4122	1.4122	1.4122	1.4122
550.1 ⁸⁾	Disc	1.4301/1.4571	1.4301/1.4571	1.4301/1.4571	1.4301/1.4571	1.4301/1.4571
59-4	Balance drum	1.4021	1.4021	1.4021	1.4021	1.4021
540	Bush	JL1040	JL1040	JL1040	JL1040	JL1040
905	Tie bolt	C45K (or 42 CrMo4)	C45K (oder 42 CrMo4)	C45K (oder 42 CrMo4)	C45K (oder 42 CrMo4)	1.6772 (Monix 3K) / 30 NCD 16

Part no.	Description	Material code					
		21	22	23	25	26	30
106	Suction casing	GP240GH+N	GP240GH+N	GP240GH+N	GP240GH+N	GP240GH+N	1.4408
107	Discharge casing	GP240GH+N	GP240GH+N	1.4408	GP240GH+N	GP240GH+N	1.4408
108	Stage casing	S355J2G3 ¹⁾ / GP240GH+N ²⁾	S355J2G3 ¹⁾ / GP240GH+N ²⁾	S355J2G3 ¹⁾ / GP240GH+N ²⁾	S355J2G3 ¹⁾ / GP240GH+N ²⁾	S355J2G3 ¹⁾ / GP240GH+N ²⁾	1.4404 ¹⁾ 1.4408 ²⁾
171	Diffuser	JL1040	1.4408	1.4408	JL1040	CC480K-GS	1.4408
210	Shaft	C45+N ⁴⁾	1.4021+QT	1.4021+QT	C45+N ⁴⁾	C45+N ⁴⁾	1.4462
230	Impeller	JL1040	1.4408	1.4408	CC480K-GS	CC480K-GS	1.4408
231	Suction impeller	1.4408	1.4408	1.4408	CC480K-GS	CC480K-GS	1.4408
350	Bearing housing	JL1040	JL1040	JL1040	JL1040	JL1040	JL1040
381/529	Plain bearing assy.	SiC/SiC	SiC/SiC	SiC/SiC	SiC/SiC	SiC/SiC	SiC/SiC
441	Stuffing box housing	GP240GH+N	GP240GH+N	1.4408	GP240GH+N	GP240GH+N	1.4408 ⁵⁾
502 ⁷⁾	Casing wear ring	JL1040	1.4138	1.4138	1.4138 ²⁾	1.4138 ²⁾	1.4571
523	Shaft sleeve	1.4057+QT800	1.4571	1.4571	1.4057+QT800	1.4057+QT800	1.4571
524	Shaft protecting sleeve	1.4122	1.4122	1.4122	1.4122	1.4122	5)
550.1 ⁸⁾	Disc	1.4301/1.4571	1.4571	1.4571	1.4301/1.4571	1.4301/1.4571	1.4571
59-4	Balance drum	1.4021	1.4021	1.4021	1.4021	1.4021	1.4404
540	Bush	JL1040	1.4021	1.4021	JL1040	JL1040	1.4138
905	Tie bolt	1.6772 (Monix 3K) / 30 NCD 16	1.6772 (Monix 3K) / 30 NCD 16	1.6772 (Monix 3K) / 30 NCD 16	1.6772 (Monix 3K) / 30 NCD 16	1.6772 (Monix 3K) / 30 NCD 16	1.6772 (Monix 3K) / 30 NCD 16

1) For pump sizes DN 32 up to 100

2) For pump sizes DN 125 and 150

3) Up to t ≤ 140 °C

4) Available in material 1.4021

5) Only provided for seal codes 61, 62, 63, 64, 69 (no packing)

6) Integrated in stage casing of pumps sizes 32 to 100.

7) Pump sizes 125 and 150 only, and casing wear ring in suction casing for pump sizes 32 to 100 of material variants 20 to 30

8) For pump sizes 32 to 100 only, also used as casing wear ring

Material Equivalents

Description	Short designation and material No.	Standard	to NF A	to ASTM
Cast iron	JL1040 / GJL-250	EN 1561	-	A48:40B
Cast bronze	CC480K-GS	EN 1982	-	B505C90250
Steel	C45+N / 1.0503+N	EN 10083-2	-	A29Gr.1045
Steel	C45K / 1.0503 K	DIN 1652	AF65C45	A663
Steel	S355J2G3 / 1.0570	EN 10025	E36-4	A678C
Cast steel	GP240GH+N / 1.0619+N	EN 10213-2	-	A216WCB
Chrome steel	1.4021+QT / X20Cr13+QT	EN 10088	-	A276:420
Chrome nickel steel	1.4122 / X35CrMo17	EN 10088	-	A276S42010 (similar)
Chrome nickel steel	1.4057+QT800 / X17CrNi16-2-QT800	EN 10088-3	-	A276:431
Chrome molybdenum cast steel	1.4138 / GX120CrMo29-2	SEW 410	Z1200D29-02-M	-
Chrome nickel steel	1.4301 / X5CrNi18-10	EN 10088	-	A276:304
Chrome nickel molybdenum steel	1.4404 / X2CrNiMo 17-12-2	EN 10088	-	A276:316L
Chrome nickel molybdenum cast steel	1.4408 / GX5CrNiMo19-11-2	EN 10213	-	A743CF8M
Chrome nickel molybdenum steel	1.4462 / X2CrNiMoN22-5-3	EN 10088	-	A473 S32950
Chrome nickel molybdenum steel	1.4571 / X6CrNiMoTi17-12-2	EN 10088	-	A276:316
Silicon carbide	SiC without free silicon	-	Carbure de silicium sans silicium libre	SiC without free silicon
Bar steel	20NiCrMo14-5 I (1.6772) / 30 NCD 16	VdTUV 337 / KSB-Materials data sheet WSZ 1179	16NC11n. A36-612 / -	A540 Gr. B24 / -
Steel	42CrMo4 / 1.7225	EN 10083-1	-	A322GR.4140 (similar)

Benefits at a glance

1st stage with special suction impeller

- low NPSH required
- reliable for suction lift operation thanks to improved suction behaviour

Newly developed hydraulics

- High efficiencies
- Low operating costs

Casing wear rings made of 1.4571

- Pump size 32 to 100: standard
- Pump size 125 to 150: depending on material variant
- Highly resistant
- Easily replaceable with low costs

Axial thrust balancing with balance drum

- Low bearing loads under variable operating conditions
- Low pressure in the shaft seal area
- Long life of rolling element bearings and shaft seal

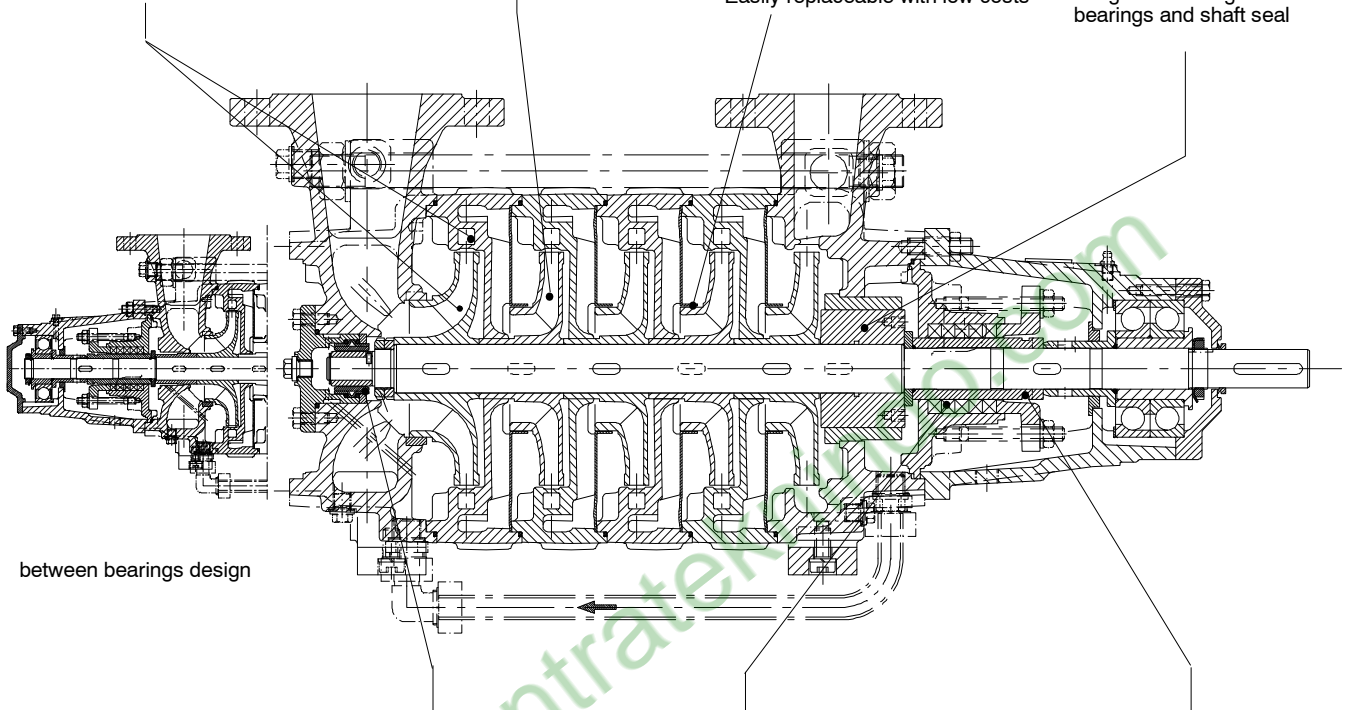

between bearings design

Adaptation of the material from many possible options (JL 1040, Bronze, GP240GH+N, 1.4408)

Plain bearings made of silicon carbide

- Longer service life
- Higher reliability
- Low maintenance costs
- One shaft seal only
- Dimensioned for start-stop operation and all speeds

Shaft sealed by

- Uncooled gland packing up to 140 °C
- Standardized mechanical seal, balanced or non-balanced
- Uncooled up to 140 °C, cooled up to 200 °C
- Single or double-acting, cartridge seals

Shaft protecting sleeve made of alloyed steel

- Efficient protection of the shaft from wear
- Quick and simple replacement of the shaft seal

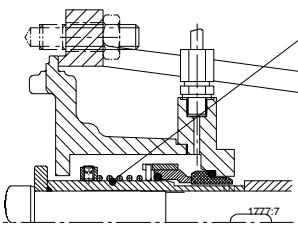
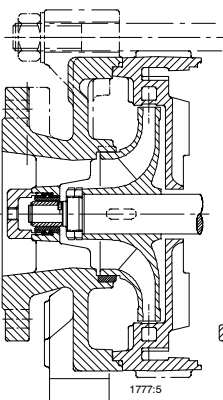

Mechanical seal, single-acting

Double acting mechanical seal, e.g. tandem arrangement

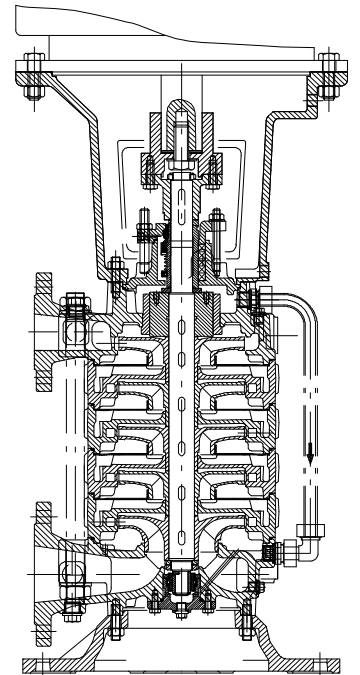

Axial inlet pump size ≥ 65

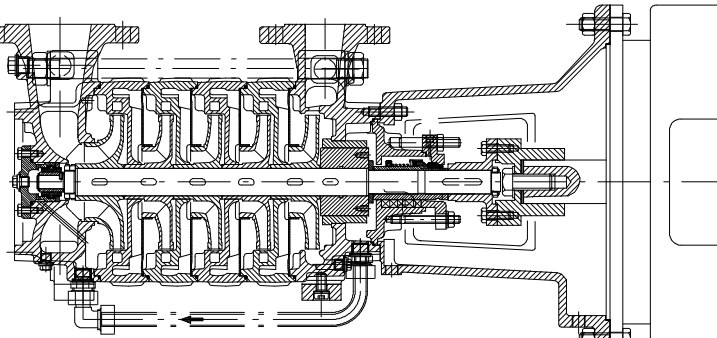

Installation type E

Installation type V; Separate rolling element bearing in the motor lantern from pump size 100 upwards

Technical data

		Unit	Pump sizes							
			32	50	65	100	125	150		
Shaft diameter	at the coupling	mm	22	28	32	40	50	60		
Bearings	Fixed bearing		6309C3	2x7309 BUA	2x7309 BUA	2x7312 BUA	2x7312 BUA	2x7315 BUA		
	Floating bearing		6309C3	6309C3	6309C3	6312 C3	6312 C3	6315 C3		
	Plain bearing		SiC							
Gland packing	Dimensions of packing rings	mm	10 x 10	10 x 10	10 x 10	12 x 12	12 x 12	16 x 16		
	Number of packing rings	off	5	5	5	5	6	6		
	Width of lantern ring	mm	20	20	20	25	25	32		
Shaft protecting sleeve	Gland packing	mm	45 Ø	45 Ø	45 Ø	56 Ø	66 Ø	78 Ø		
	Mechanical seal	mm	35/38Ø ¹⁾	35/38Ø ¹⁾	40 Ø	50 Ø	60 Ø	70 Ø		
Drive (P/n value)	Shaft C 45 N		0.0214	0.0523	0.0697	0.15	0.3016	0.5371		
	Shaft 1.4021+QT		0.0346	0.0846	0.1128	0.2426	0.4879	0.8688		
	Shaft 1.4462		0.0302	0.0738	0.0984	0.2118	0.4258	0.7582		
Other	Hydraulics		2.1	3.1/4.1	5.1/6.1	7.1/8.1	9.1/9.2	10.1/10.2	11.1/11.2	12.1/12.2
	Max. impeller diameter	mm	142	170/173	193/214	241/245	301/273	305/270	378/342	382/337
	Length of spacer sleeve for spacer-type couplings	mm	140	140	140	180	180	200		

1) Balanced seal: 35 mm, non-balanced seal: 38 mm

Casing

Cast discharge casing with pump feet bolted below, The seal housings are separate components. Stage casings, discharge casings and seal housings sealed with confined O-rings. Slightly elastic or non-elastic sealing rings (PTFE etc.) can be installed.

Standard flange designs

Material variant	EN		ASME Class	
	Suction flange	Discharge flange	Suction flange	Discharge flange
10	1092-2;PN16	1092-2;PN40	125 RF	250 RF
11	1092-2;PN16	1092-2;PN40	125 RF	250 RF
12	1092-2;PN16	1092-2;PN40	125 RF	250 RF
13	1092-2;PN16	1092-2;PN40	125 RF	250 RF
20	1092-1;PN25	1092-1;PN63	300 RF	600 RF ²⁾
21	1092-1;PN25	1092-1;PN63	300 RF	600 RF ²⁾
22	1092-1;PN25	1092-1;PN63	300 RF	600 RF ²⁾
23	1092-1;PN25	1092-1;PN63	300 RF	600 RF ²⁾
25	1092-1;PN25	1092-1;PN63	300 RF	600 RF ²⁾
26	1092-1;PN25	1092-1;PN63	300 RF	600 RF ²⁾
30	1092-1;PN25	1092-1;PN63	300 RF	600 RF ²⁾

2) for pump size 32: discharge flange DN 1/4" can also be supplied with DN 1 1/2", if requested

Other flange machining variants on request.

Drive

By three-phase squirrel cage motor, types of construction:

Installation types A, B, C and D: IMB3

Installation types E F: IMV1 up to 45 kW,
>45 kW IMB 35

Installation type V: IMV1

Enclosure: IP 55/IP 23

Thermal class: F

Direction of rotation:

Installation types A, B, C, E, F, V clockwise, viewed from the drive end

Installation type D counterclockwise, viewed from the drive end

Options: special voltages,
explosion proof, PTC
resistors

Couplings

Flexible couplings without/with spacer. Others on request.

Close-coupled pumps up to DN 65 with rigid coupling;

> DN 65 with flexible couplings without spacer sleeve.

Coupling guard

to EN 294.

Tread-proof coupling guard possible.

Baseplates

Sectional steel, welded or U-rails for complete unit (pump and motor).

Close-coupled units are supplied with two U-rails for easier installation.

Documentation

Printed documents matched to CE requirements

- Dealers' catalogue 1777.178
- Dimensions tables 1777.3
- Installation plan 1777.39..
- Operating instructions 1777.8
- Performance curve booklet 50 Hz 1777.450
- Performance curve booklet 60 Hz 1777.460

General assembly drawing with list of components

CD

Inspections/Certificates

Standard without special certificates:

Hydrostatic internal pressure test of pressure-retaining components:
Discharge casing, stage casings, suction casing and seal housing at least 1.3 times the max. internal operating pressure.

On customer's request

Material tests:

- Test report 2.2 to EN 10204 for the components as per QCP ZN 58014

At extra charge

- Test certificate 3.1B to EN 10204.
- Dimensions check
- Coating inspection
- Final inspection
- Strip test
- Hydrostatic pressure test of pressure-retaining components

Hydraulic performance tests:

- Hydraulic performance test to ISO 9906
- NPSH-test

Other tests available:

- Balancing test
- Vibration test

Guarantee conditions

The duty point shall be limited to the area defined by the performance curve. The minimum flow rate specified in the quotation must be observed.

Pump operation outside the performance curve range may cause destruction of the pump set and loss of warranty.

The NPSH values given in the performance curve booklet correspond to the inception of cavitation. They apply to cold water without any gases.

To allow for measuring tolerances and production-related scattering, a margin of 10 %, but not less than 0.5 m must be taken into account.

The total heads and outputs apply to liquids with a density of $\rho = 1.0 \text{ kg/dm}^3$ and a max. kinematic viscosity ν of $20 \text{ mm}^2/\text{s}$.

Forces and moments

Multitec pumps are designed in such a way that they can withstand forces and moments in acc. with ISO 5199.

Noise characteristics

Rated power input P_N (kW)	Sound pressure level L_{pA} (dB) ¹⁾			
	Pump only		Pump with motor	
	1450 1/min	2900 1/min	1450 1/min	2900 1/min
2.2	55.5	57.0	60.0	65.0
3.0	58.0	60.0	61.5	66.5
4.0	59.0	61.0	63.0	68.0
5.5	61.0	63.0	64.5	69.5
7.5	63.0	65.0	66.0	71.0
9.0	64.0	66.0	67.5	72.5
11.0	65.0	67.0	68.0	73.0
15.0	66.0	68.0	69.5	74.5
18.5	67.0	69.0	70.5	75.5
22.0	68.0	70.0	71.5	76.5
30.0	69.0	71.0	73.0	78.0
37.0	69.5	72.0	73.5	78.5
45.0	70.5	73.0	74.5	79.0
55.0	71.0	73.5	75.0	79.5
75.0	71.5	74.0	76.5	81.5
90.0	72.0	74.5	77.0	82.0
110.0	72.5	75.0	77.5	82.5
132.0	73.0	75.5	78.0	83.0
160.0	73.5	76.0	78.5	83.5
200.0	74.5	77.0	79.5	84.5
250.0	75.0	77.5		
315.0	75.5	78.0		

1) Measured at a distance of 1 m from the pump outline (as per DIN 45635, Parts 1 and 24)

The design department must always be consulted when noise levels have to be guaranteed.

Noise characteristics for higher power ratings on request.

Coating/Preservation

(to AN 1865)

Material variant

10/11/12/13/20/21/25/26	$\leq 140 \text{ }^\circ\text{C}$	R 6 6 6 T
20/21	$> 140 \text{ }^\circ\text{C}$	N ¹⁾ 7 7 7 T
22/23/30	$\leq 140 \text{ }^\circ\text{C}$	N 6 6 6 U
22/23/30	$> 140 \text{ }^\circ\text{C}$	N 7 7 7 U

Key:

Treatment of unmachined parts

Coating - pressure-retaining components

Coating - bearing bracket, baseplate

Coating - motor

Preservation after test run

R = reaction primer, all parts and surfaces

N = reaction primer, wetted components without first primer coat (internal and external)

6 = synthetic enamel (water-dilutable) RAL 5002 - ultra-marine blue

7 = heat-resistant paint RAL 9007 - aluminium grey

T = flushed with drinking water compatible preservation liquid

U = untreated, blank parts liable to rust treated with protective coating / water repellent.

1) for R impellers

Recommended stock of spare parts for two years' operation acc. to DIN 24 296

Part no.	Description	Number of pumps (including stand-by pumps)						
		2	3	4	5	6 and 7	8 and 9	10 and more
For shaft seal codes 65 and 66 (gland packing)								
210	Shaft with small parts	1	1	2	2	2	3	30 %
230	Impeller (set = S)	1	1	1	2	2	3	30 %
231	Suction impeller	1	1	1	2	2	3	30 %
320.1 ⁴⁾	Angular contact ball bearings (set)	1	1	2	2	3	4	50 %
320.2 ⁴⁾	Radial ball bearing	1	1	2	2	3	4	50 %
381 ⁵⁾	Bearing cartridge	1	1	2	2	3	4	50 %
411.6/7	V-Ring (set)	4	8	8	8	9	12	150 %
412	O-ring (set = S)	4	8	8	8	9	12	150 %
461	Gland packing (set)	4	6	8	8	9	12	150 %
502 ¹⁾	Casing wear ring (set = S)	2	2	2	3	3	4	50 %
520	Sleeve	1	1	2	2	3	4	50 %
524	Shaft protecting sleeve	2	2	2	3	3	4	50 %
525	Spacer sleeve	2	2	2	3	3	4	50 %
529	Bearing sleeve	1	1	2	2	3	4	50 %
540	Bush	1	1	1	2	2	3	30 %
550.1 ²⁾	Disc	2	2	2	3	3	4	50 %
59-4	Balance drum	1	1	1	2	2	3	30 %
For shaft seal codes 61, 62, 63 and 64 (with mechanical seal)								
433	Compl. mechanical seal ³⁾	2	3	4	5	6	7	90 %
523	Shaft sleeve (set)	2	2	2	3	3	4	50 %

1) Pump sizes 125 and 150 only, and casing wear ring in suction casing for pump sizes 32 to 100 of material variants 20 to 30.
2) Only pump sizes 32 up to 100

3) The parts 461 and 524 are not installed
4) Parts form a subassembly with part no. 520
5) Part 381 forms a subassembly with part 529

Nozzle Positions

Nozzle positions are variable. The nozzle position required must be entered in the selection software when ordering.

N.B.! Nozzle position 0-0 (or fig. 2 for vertical installation) is only possible for all pump sizes and material variants from the third stage upwards! Exception: DN 150 in material variants 10, 11 and 12: on these pumps, nozzle position 0-0 is possible **from the second stage** upwards!

Nozzle positions are defined as viewed from the drive end.

1. Horizontal installation (A, B, C, D, E and F)

The first letter defines the position of the suction nozzle, the second letter that of the discharge nozzle.

Nozzle positions on horizontal pumps:

- A = axial suction nozzle
- 0 = suction and/or discharge nozzle on top
- R = suction and/or discharge nozzle on the right
- L = suction and/or discharge nozzle on the left

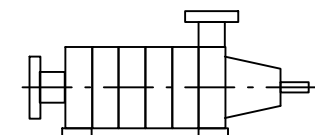

Examples of nozzle position codes in the selection software:

A - 0

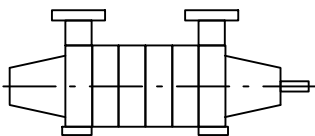

0 - 0

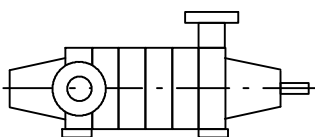

L - 0

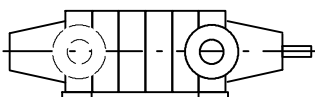

R - L

2. Vertical installation

The suction nozzle (bottom) is regarded as a fixed point. The illustration number indicates the displacement of the discharge nozzle versus the suction nozzle.

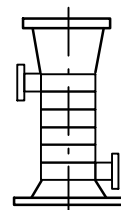

Fig. 1

1 = turned by 180°

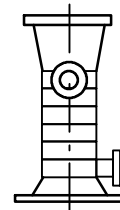

Fig. 3

3 = turned by 90° to the left

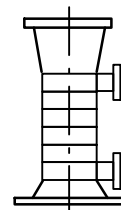

Fig. 2

2 = same position

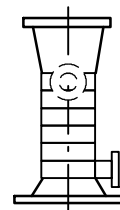
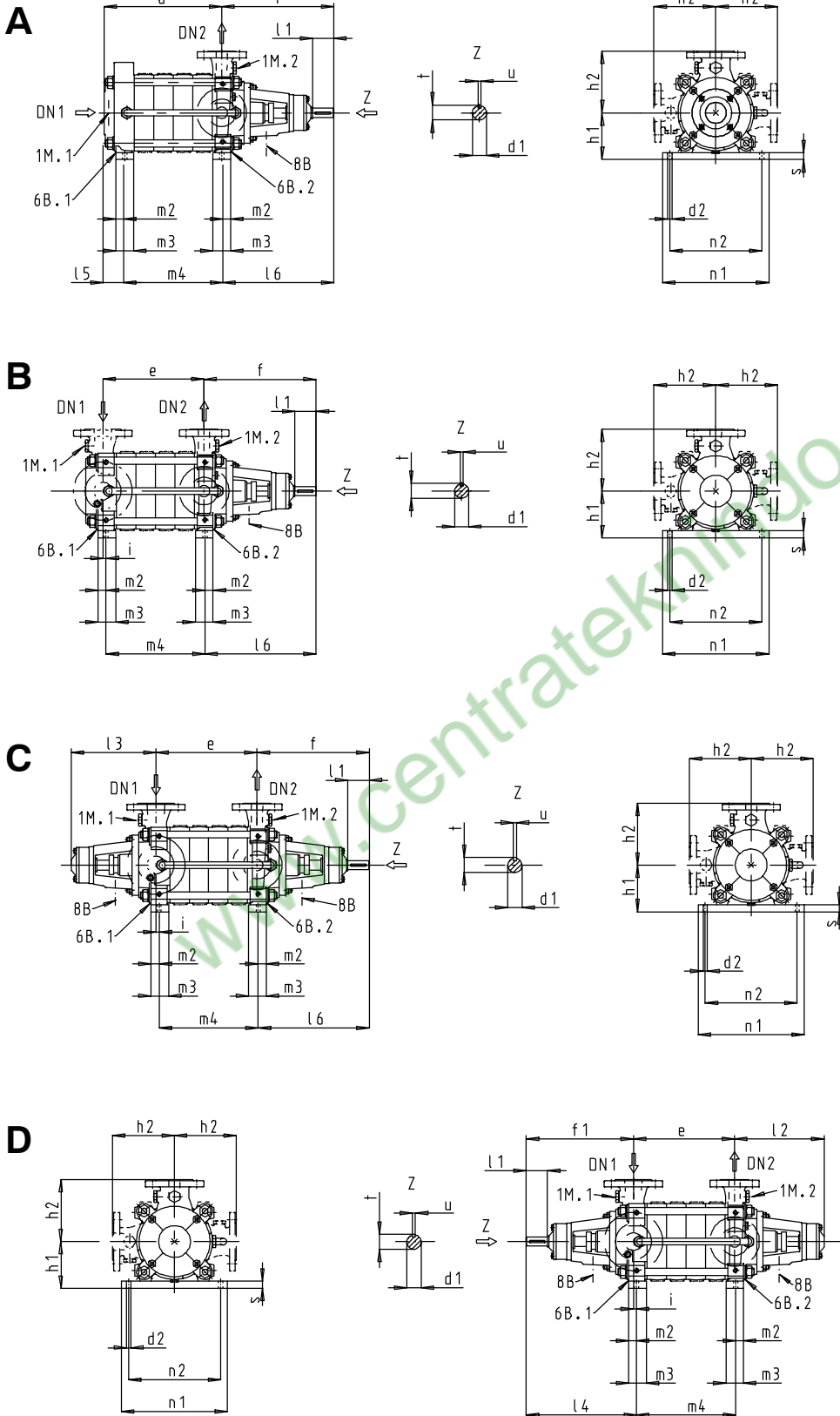

Fig. 4

4 = turned by 90° to the right

Multitec A, B, C, D



Multitec	d ₁	t	u
32	22	24.5	6
50	28	31	8
65	32	35	10
100	40	43	12
125	50	53.5	14
150	60	64	18

Anschlüsse / Connections / Raccords / Attacchi / Aansluitingen / Conexiones

	G = ISO 228/1 Rp = ISO 7/1	Multitec A						Multitec B, C, D					
		32	50	65	100	125	150	32	50	65	100	125	150
1M.1	G	-	-	1/2	1/2	1/2	1	1/2	1/2	1/2	1/2	1/2	1/2
1M.2	G	1/2	1/2	1/2	1/2	1/2	1/2	1/2	1/2	1/2	1/2	1/2	1/2
6B.1	G	-	-	1/4	1/2	1/2	1/2	1/4	1/4	1/2	1/2	1/2	1
6B.2	G	1/4	1/4	1/2	1/2	1/2	1/2	1/4	1/4	1/2	1/2	1/2	1/2
8B	Rp	3/8	3/8	3/8	3/8	3/8	3/8	3/8	3/8	3/8	3/8	3/8	3/8

Multitec A, B, C, D	1)	2)	DN ₁		DN ₂	a	d _{1 k7}	d ₂	e	f	f ₁	h ₁	h ₂	i	l ₁	l ₂	l ₃	l ₄	l ₅	l ₆	m ₂	m ₃	m ₄	n ₁	n ₂	mm s
			axial	radial																						
32	2	10	65	50	32	168	22	16	121	309	295	132	175	9	50	255	241	304	56	306	20	40	115	330	290	20
	3	11	65	50	32	223	22	16	176	309	295	132	175	9	50	255	241	304	56	306	20	40	170	330	290	20
	4	12	65	50	32	278	22	16	231	309	295	132	175	9	50	255	241	304	56	306	20	40	225	330	290	20
	5	13	65	50	32	333	22	16	286	309	295	132	175	9	50	255	241	304	56	306	20	40	280	330	290	20
	6	21	65	50	32	388	22	16	341	309	295	132	175	9	50	255	241	304	56	306	20	40	335	330	290	20
	7	22	65	50	32	443	22	16	396	309	295	132	175	9	50	255	241	304	56	306	20	40	390	330	290	20
	8	23	65	50	32	498	22	16	451	309	295	132	175	9	50	255	241	304	56	306	20	40	445	330	290	20
	9	25	65	50	32	553	22	16	506	309	295	132	175	9	50	255	241	304	56	306	20	40	500	330	290	20
	10	26	65	50	32	608	22	16	561	309	295	132	175	9	50	255	241	304	56	306	20	40	555	330	290	20
	11	30	65	50	32	663	22	16	616	309	295	132	175	9	50	255	241	304	56	306	20	40	610	330	290	20
	12		65	50	32	718	22	16	671	309	295	132	175	9	50	255	241	304	56	306	20	40	665	330	290	20
	13		65	50	32	773	22	16	726	309	295	132	175	9	50	255	241	304	56	306	20	40	720	330	290	20
	14		65	50	32	828	22	16	781	309	295	132	175	9	50	255	241	304	56	306	20	40	775	330	290	20
	50	2	10	100	80	50	190 *)	28	16	151	350	338	150	200	18	61	262	250	356	57 *)	355	20	40	128	330	290
3		11	100	80	50	252 *)	28	16	213	350	338	150	200	18	61	262	250	356	57 *)	355	20	40	190	330	290	20
4		12	100	80	50	314 *)	28	16	275	350	338	150	200	18	61	262	250	356	57 *)	355	20	40	252	330	290	20
5		13	100	80	50	376 *)	28	16	337	350	338	150	200	18	61	262	250	356	57 *)	355	20	40	314	330	290	20
6		20	100	80	50	438 *)	28	16	399	350	338	150	200	18	61	262	250	356	57 *)	355	20	40	376	330	290	20
7		21	100	80	50	500 *)	28	16	461	350	338	150	200	18	61	262	250	356	57 *)	355	20	40	438	330	290	20
8		22	100	80	50	562 *)	28	16	523	350	338	150	200	18	61	262	250	356	57 *)	355	20	40	500	330	290	20
9		23	100	80	50	624 *)	28	16	585	350	338	150	200	18	61	262	250	356	57 *)	355	20	40	562	330	290	20
10		25	100	80	50	686 *)	28	16	647	350	338	150	200	18	61	262	250	356	57 *)	355	20	40	624	330	290	20
11		26	100	80	50	748 *)	28	16	709	350	338	150	200	18	61	262	250	356	57 *)	355	20	40	686	330	290	20
12		30	100	80	50	810 *)	28	16	771	350	338	150	200	18	61	262	250	356	57 *)	355	20	40	748	330	290	20
13			100	80	50	872 *)	28	16	833	350	338	150	200	18	61	262	250	356	57 *)	355	20	40	810	330	290	20
14			100	80	50	934 *)	28	16	895	350	338	150	200	18	61	262	250	356	57 *)	355	20	40	872	330	290	20
15			100	80	50	996 *)	28	16	957	350	338	150	200	18	61	262	250	356	57 *)	355	20	40	934	330	290	20
65		2	10	125	100	65	247	32	20	189	393	380	190	225	18	82	303	291	399	77	394	30	60	169	405	365
	3	11	125	100	65	326	32	20	268	393	380	190	225	18	82	303	291	399	77	394	30	60	248	405	365	25
	4	12	125	100	65	405	32	20	347	393	380	190	225	18	82	303	291	399	77	394	30	60	327	405	365	25
	5	13	125	100	65	484	32	20	426	393	380	190	225	18	82	303	291	399	77	394	30	60	406	405	365	25
	6	20	125	100	65	563	32	20	505	393	380	190	225	18	82	303	291	399	77	394	30	60	485	405	365	25
	7	21	125	100	65	642	32	20	584	393	380	190	225	18	82	303	291	399	77	394	30	60	564	405	365	25
	8	22	125	100	65	721	32	20	663	393	380	190	225	18	82	303	291	399	77	394	30	60	643	405	365	25
	9	23	125	100	65	800	32	20	742	393	380	190	225	18	82	303	291	399	77	394	30	60	722	405	365	25
	10	25	125	100	65	879	32	20	821	393	380	190	225	18	82	303	291	399	77	394	30	60	801	405	365	25
	11	30	125	100	65	958	32	20	900	393	380	190	225	18	82	303	291	399	77	394	30	60	880	405	365	25
	100	2	10	150	125	100	306	40	26	233	472	463	235	275	30	110	339	329	492	103	462	35	70	213	504	450
3		11	150	125	100	396	40	26	323	472	463	235	275	30	110	339	329	492	103	462	35	70	303	504	450	30
4		12	150	125	100	486	40	26	413	472	463	235	275	30	110	339	329	492	103	462	35	70	393	504	450	30
5		13	150	125	100	576	40	26	503	472	463	235	275	30	110	339	329	492	103	462	35	70	483	504	450	30
6		20	150	125	100	666	40	26	593	472	463	235	275	30	110	339	329	492	103	462	35	70	573	504	450	30
7		21	150	125	100	756	40	26	683	472	463	235	275	30	110	339	329	492	103	462	35	70	663	504	450	30
8		22	150	125	100	846	40	26	773	472	463	235	275	30	110	339	329	492	103	462	35	70	753	504	450	30
9		23	150	125	100	936	40	26	863	472	463	235	275	30	110	339	329	492	103	462	35	70	843	504	450	30
10		25	150	125	100	1026	40	26	953	472	463	235	275	30	110	339	329	492	103	462	35	70	933	504	450	30
11		30	150	125	100	1116	40	26	1043	472	463	235	275	30	110	339	329	492	103	462	35	70	1023	504	450	30
125		2	10	200	150	125	393	50	26	292	488	478	300	325	10	110	355	345	488	112	464	22	94	306	320	250
	3	11	200	150	125	505	50	26	404	488	478	300	325	10	110	355	345	488	112	464	22	94	418	320	250	30
	4	12	200	150	125	617	50	26	516	488	478	300	325	10	110	355	345	488	112	464	22	94	530	320	250	30
	5	13	200	150	125	729	50	26	628	488	478	300	325	10	110	355	345	488	112	464	22	94	642	320	250	30
	6		200	150	125	841	50	26	740	488	4															

Multitec E, F

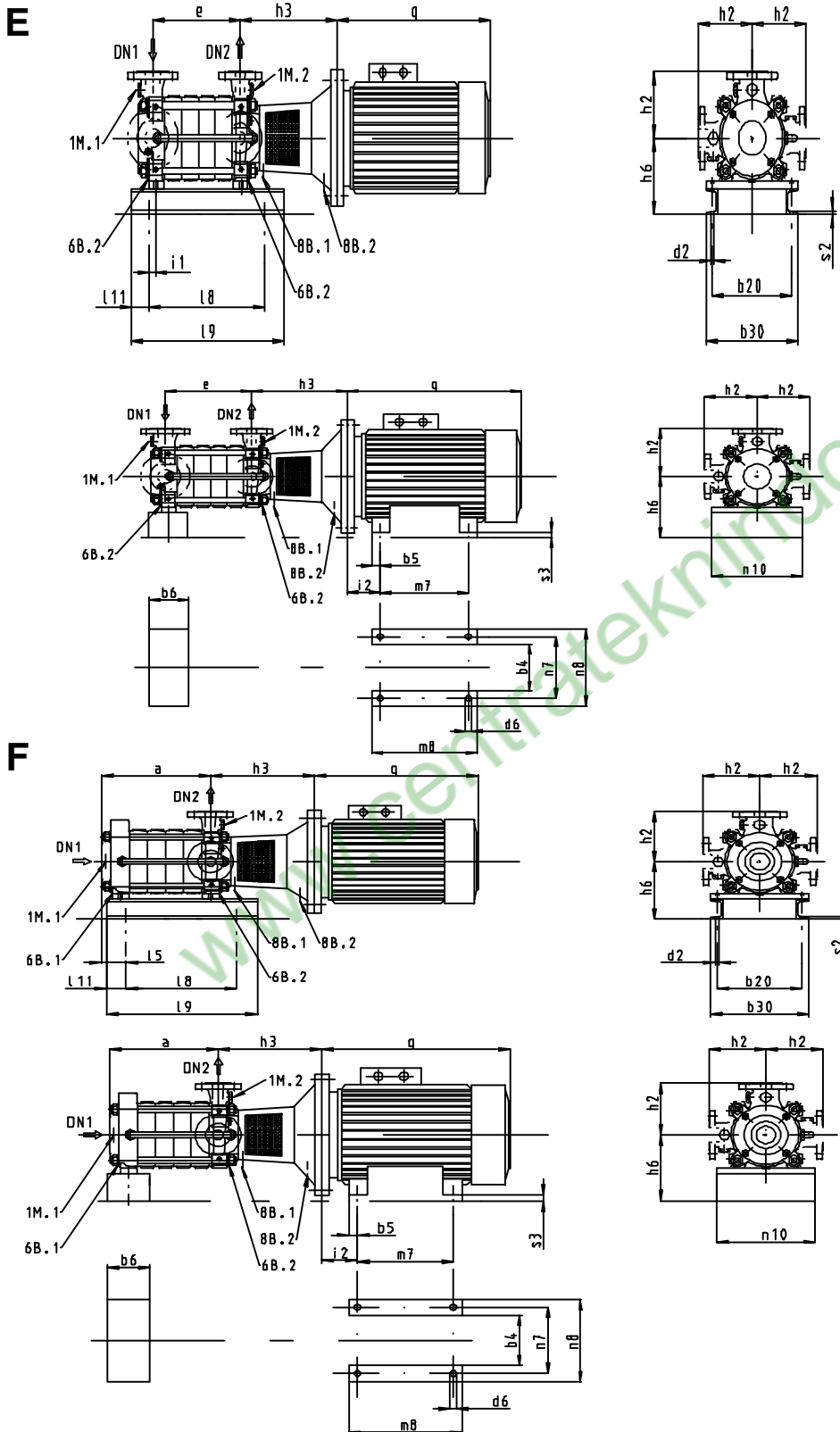

Anschlüsse / Connections / Raccords / Attacchi / Aansluitingen / Conexiones

	G = ISO 228/1 Rp = ISO 7/1	Multitec E						Multitec F					
		32	50	65	100	125	150	32	50	65	100	125	150
1M.1	G	1/2	1/2	1/2	1/2	1/2	1/2	-	-	1/2	1/2	1/2	1
1M.2	G	1/2	1/2	1/2	1/2	1/2	1/2	1/2	1/2	1/2	1/2	1/2	1/2
6B.1	G	1/4	1/4	1/2	1/2	1/2	1	-	-	1/4	1/2	1/2	1/2
6B.2	G	1/4	1/4	1/2	1/2	1/2	1/2	1/4	1/4	1/2	1/2	1/2	1/2
8B.1	Rp	3/8	3/8	3/8	3/8	3/8	3/8	3/8	3/8	3/8	3/8	3/8	3/8
8B.2	Rp	3/8	3/8	3/8	3/8	3/8	3/8	3/8	3/8	3/8	3/8	3/8	3/8

Multitec E. F	1)	DN ₁		DN ₂	a	b ₂₀	b ₃₀	d ₂	e	h ₂	i ₁	l ₅	l ₈	l ₉	l ₁₁	n ₁₀	s ₂	mm
		axial	radial															
32	2	65	50	32	168	290	330	18	121	175	9	57	135	455	60	330	4	
	3	65	50	32	223	290	330	18	176	175	9	57	190	500	60	330	4	
	4	65	50	32	278	290	330	18	231	175	9	57	245	550	60	330	4	
	5	65	50	32	333	290	330	18	286	175	9	57	300	610	60	330	4	
	6	65	50	32	388	290	330	18	341	175	9	57	355	670	60	330	4	
50	2	100	80	50	190	290	330	18	151	200	18	57	190	500	60	330	4	
	3	100	80	50	252	290	330	18	213	200	18	57	245	550	60	330	4	
	4	100	80	50	314	290	330	18	275	200	18	57	300	610	60	330	4	
	5	100	80	50	376	290	330	18	337	200	18	57	355	670	60	330	4	
	6	100	80	50	438	290	330	18	399	200	18	57	410	730	60	330	4	
65	2	125	100	65	247	365	405	18	189	225	18	77	200	530	60	405	4	
	3	125	100	65	326	365	405	18	268	225	18	77	270	610	60	405	4	
	4	125	100	65	405	365	405	18	347	225	18	77	350	690	60	405	4	

1) Stufenzahl Number of stages Nombre d'étages Numero degli stadi Aantal trappen N° de etapas

MTC E and F 32-50-65 Table of variable dimensions depending motors IP 55 50Hz 2 and 4 poles

Form	Motor / motor / Moteur / Motor / Motore / Motor			b ₆	d ₆	h ₃ MTC			h ₆ MTC			i ₂	m ₇	m ₈ ¹⁾	n ₇ ¹⁾	n ₈ ¹⁾	n ₁₀ ¹⁾	q ¹⁾	s ₃ ¹⁾	mm
	kW	Flange FF	IEC			32	50	65	32	50	65									
V1	2.2	215	100L	-	-	-	-	-	-	-	-	-	-	-	-	-	-	-	-	-
	3	215	100L	-	-	302	-	-	-	-	-	-	-	-	-	-	-	313	-	-
	4	215	112M	-	-	-	-	-	-	-	-	-	-	-	-	-	-	334	-	-
	5.5	265	132S	-	-	322	329	-	192	-	-	-	-	-	-	-	-	374	-	-
	7.5	265	132S	-	-	-	-	-	-	-	-	-	-	-	-	-	-	-	-	-
	11	300	160M	-	-	352	-	-	-	-	-	-	-	-	-	-	-	-	-	-
	15	300	160M	-	-	352	-	-	-	210	-	-	-	-	-	-	-	-	478	-
	18.5	300	160L	-	-	-	359	-	-	-	-	-	-	-	-	-	-	-	-	-
	22	300	180M	-	-	-	-	381	-	-	-	-	-	-	-	-	-	-	602	-
	30	350	200L	-	-	-	-	-	-	-	-	-	-	-	-	-	-	-	660	-
37	350	200L	-	-	-	362	-	-	-	-	-	-	-	-	-	-	-	-	-	
B35	45	400	225M	140	19	-	-	384	-	-	225	149	286	361	356	428	240	667	24	
	55	500	250M	50	24	-	-	414	-	-	280	168	349	409	406	506	240	790	72	
	78	500	280S	50	24	-	-	-	-	-	280	190	368	479	457	557	240	865	42	

1) informationshalber / for information only! / A titre indicatif / para información / per informazione / ter informatie

Multitec V

V

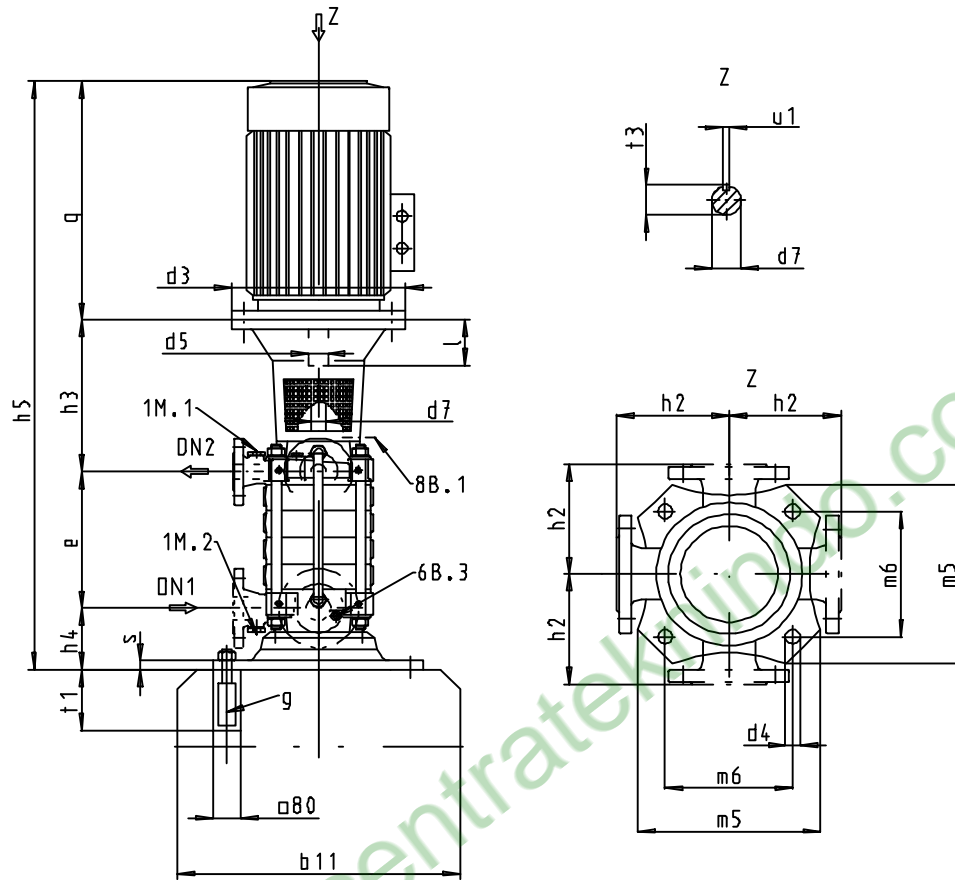

MTC V	q	h _s	IP55															IP23																	
			50 / 60 Hz					h ₃					50 / 60 Hz					h ₃																	
			2-pole		4-pole			2-pole		4-pole			2-pole		4-pole			2-pole		4-pole															
kW	d ₃	d ₅	l	d ₃	d ₅	l	32	50	65	100	125	150	32	50	65	100	125	150	d ₃	d ₅	l	d ₃	d ₅	l	32	50	65	100	125	32	50	65	100	125	150
2,2	-	-	-	250	28	60	302	309	331	-	-	-	302	309	331	-	-	-	-	-	-	-	-	-	-	-	-	-	-	-	-	-	-	-	
3,0	250	28	60	250	28	60	302	309	331	-	-	-	302	309	331	-	-	-	-	-	-	-	-	-	-	-	-	-	-	-	-	-	-	-	
4,0	250	28	60	250	28	60	302	309	331	-	-	-	302	309	331	-	-	-	-	-	-	-	-	-	-	-	-	-	-	-	-	-	-	-	-
5,5	300	38	80	300	38	80	322	329	351	-	-	-	322	329	351	-	-	-	-	-	-	-	-	-	-	-	-	-	-	-	-	-	-	-	-
7,5	300	38	80	300	38	80	322	329	351	-	-	-	322	329	351	-	-	-	-	-	-	-	-	-	-	-	-	-	-	-	-	-	-	-	-
11,0	350	42	110	350	42	110	352	359	381	585	601	-	352	359	381	585	601	-	400	48	110	400	48	110	355	362	381	585	601	355	362	381	585	601	-
15,0	350	42	110	350	42	110	352	359	381	585	601	-	352	359	381	585	601	-	400	48	110	400	48	110	355	362	381	585	601	355	362	381	585	601	-
18,5	350	42	110	350	48	110	352	359	381	585	601	-	352	359	381	585	601	-	400	48	110	400	48	110	355	362	381	585	601	355	362	381	585	601	-
22,0	350	48	110	350	48	110	352	359	381	585	601	-	352	359	381	585	601	-	400	48	110	400	55	110	355	362	381	585	601	355	362	381	585	601	-
30,0	400	55	110	400	55	110	355	362	381	585	601	-	355	362	381	585	601	-	400	55	110	400	55	110	355	362	381	585	601	355	362	414	585	601	-
37,0	400	55	110	450	60	140	355	362	381	585	601	-	385	392	414	615	631	-	400	55	110	450	60	110	355	362	381	585	601	385	392	414	615	631	-
45,0	450	55	110	450	60	140	355	362	384	615	631	-	385	392	414	615	631	-	450	60	140	450	60	140	385	392	414	615	631	385	392	414	615	631	-
55,0	550	60	140	550	65	140	-	392	414	617	633	740	-	392	414	617	633	740	450	60	140	550	65	140	-	392	414	615	631	-	422	414	617	633	740
75,0	550	65	140	550	75	140	-	392	414	617	633	740	-	392	414	617	633	740	550	60	140	660	75	140	-	422	414	617	633	-	444	647	663	770	
90,0	550	65	140	550	75	140	-	392	414	617	633	740	-	392	414	617	633	740	660	65	140	660	75	140	-	-	444	647	663	-	444	647	663	770	
110,0	660	65	140	660	80	170	-	-	444	647	663	770	-	-	444	647	663	770	660	65	140	660	80	170	-	-	444	647	663	-	444	647	663	770	
132,0	660	65	140	660	80	170	-	-	444	647	663	770	-	-	444	647	663	770	660	65	140	660	80	170	-	-	444	647	663	-	444	647	663	770	
160,0	660	65	140	660	80	170	-	-	-	647	663	770	-	-	-	647	663	770	-	-	-	-	-	-	-	-	-	-	-	-	-	-	-	-	-
200,0	660	70	140	660	90	170	-	-	-	-	770	-	-	-	-	-	770	-	-	-	-	-	-	-	-	-	-	-	-	-	-	-	-	-	-

1) vom Fabrikat abhängig depends on motor brand en fonction de la marque di pendente dal costruttore afhankelijk van hec fabrikaat depeinde de la impresa costrutóra

Anschlüsse / Connections / Raccords / Attacchi / Aansluitingen / Conexiones

	G = ISO 228/1 Rp = ISO 7/1	Multitec V					
		32	50	65	100	125	150
1M.1	G	1/2	1/2	1/2	1/2	1/2	1/2
1M.2	G	1/2	1/2	1/2	1/2	1/2	1/2
6B.3	G	1/4	1/4	1/2	1/2	1/2	1
8B	Rp	3/8	3/8	3/8	3/8	3/8	3/8

Multitec V	1)	DN ₁	DN ₂	b ₁₁	d ₄	d ₇	e	g	h ₂	h ₄	m ₅	m ₆	s	t ₁	t ₃	u ₁
32	2	50	32	490	18	30	121	M16x250 MU	175	129	345	266	20	250	33	8
	3	50	32	490	18	30	176	M16x250 MU	175	129	345	266	20	250	33	8
	4	50	32	490	18	30	231	M16x250 MU	175	129	345	266	20	250	33	8
	5	50	32	490	18	30	286	M16x250 MU	175	129	345	266	20	250	33	8
	6	50	32	490	18	30	341	M16x250 MU	175	129	345	266	20	250	33	8
	7	50	32	490	18	30	396	M16x250 MU	175	129	345	266	20	250	33	8
	8	50	32	490	18	30	451	M16x250 MU	175	129	345	266	20	250	33	8
	9	50	32	490	18	30	506	M16x250 MU	175	129	345	266	20	250	33	8
	10	50	32	490	18	30	561	M16x250 MU	175	129	345	266	20	250	33	8
	11	50	32	490	18	30	616	M16x250 MU	175	129	345	266	20	250	33	8
	12	50	32	490	18	30	671	M16x250 MU	175	129	345	266	20	250	33	8
	13	50	32	490	18	30	726	M16x250 MU	175	129	345	266	20	250	33	8
14	50	32	490	18	30	781	M16x250 MU	175	129	345	266	20	320	33	8	
50	2	80	50	490	18	30	151	M16x320 MU	200	136	345	266	20	320	33	8
	3	80	50	490	18	30	213	M16x320 MU	200	136	345	266	20	320	33	8
	4	80	50	490	18	30	275	M16x320 MU	200	136	345	266	20	320	33	8
	5	80	50	490	18	30	337	M16x320 MU	200	136	345	266	20	320	33	8
	6	80	50	490	18	30	399	M16x320 MU	200	136	345	266	20	320	33	8
	7	80	50	490	18	30	461	M16x320 MU	200	136	345	266	20	320	33	8
	8	80	50	490	18	30	523	M16x320 MU	200	136	345	266	20	320	33	8
	9	80	50	490	18	30	585	M16x320 MU	200	136	345	266	20	320	33	8
	10	80	50	490	18	30	585	M16x320 MU	200	136	345	266	20	320	33	8
	65	2	100	65	540	18	35	189	M16x320 MU	225	170	400	304	22	320	38
3		100	65	540	18	35	268	M16x320 MU	225	170	400	304	22	320	38	10
4		100	65	540	18	35	347	M16x320 MU	225	170	400	304	22	320	38	10
5		100	65	540	18	35	426	M16x320 MU	225	170	400	304	22	320	38	10
6		100	65	540	18	35	505	M16x320 MU	225	170	400	304	22	320	38	10
7		100	65	540	18	35	584	M16x320 MU	225	170	400	304	22	320	38	10
8		100	65	540	18	35	663	M16x320 MU	225	170	400	304	22	320	38	10
100		2	125	100	690	33	40	233	M30x400 MU	275	212	545	405	30	400	43
	3	125	100	690	33	40	323	M30x400 MU	275	212	545	405	30	400	43	12
	4	125	100	690	33	40	413	M30x400 MU	275	212	545	405	30	400	43	12
	5	125	100	690	33	40	503	M30x400 MU	275	212	545	405	30	400	43	12
	6	125	100	690	33	40	593	M30x400 MU	275	212	545	405	30	400	43	12
	7	125	100	690	33	40	683	M30x400 MU	275	212	545	405	30	400	43	12
	8	125	100	690	33	40	773	M30x400 MU	275	212	545	405	30	400	43	12
	9	125	100	690	33	40	863	M30x400 MU	275	212	545	405	30	400	43	12
	10	125	100	690	33	40	953	M30x400 MU	275	212	545	405	30	400	43	12
	11	125	100	690	33	40	1043	M30x400 MU	275	212	545	405	30	400	43	12
	125	2	150	125	690	33	50	292	M30x400 MU	325	227	545	405	30	400	53.5
3		150	125	690	33	50	404	M30x400 MU	325	227	545	405	30	400	53.5	14
4		150	125	690	33	50	516	M30x400 MU	325	227	545	405	30	400	53.5	14
5		150	125	690	33	50	628	M30x400 MU	325	227	545	405	30	400	53.5	14
6		150	125	690	33	50	740	M30x400 MU	325	227	545	405	30	400	53.5	14
7		150	125	690	33	50	852	M30x400 MU	325	227	545	405	30	400	53.5	14

1) Stufenzahl Number of stages Nombre d'étages Numero degli stadi Aantal trappen N° de etapas

www.centrateknindo.com

www.centrateknindo.com

www.centrateknindo.com

